

W10L100-SPH1-B, 10.1-inch Stainless B Series Display

Stainless IP65 with Waterproof Connector Solutions

Push-buttons bring control and indication directly to the work area, eliminating wasted movement and increasing productivity. In addition, the physical buttons are especially needed for critical tasks like emergency shutdowns. When an emergency situation occurs, we don't want to waste time navigating through HMI screens but a simple and quick way to shut down the process. In terms of machine integration, push-button devices are easy to install and wire, and straightforward for understanding the function and use. Averagely the wiring time is saved by over 60%, and the installation cost is reduced by more than 30%.



Highlights

- Projected capacitive multi-touch screen
- True flat, easy-to-clean front surface
- Full IP65 waterproof enclosure, good corrosion resistance
- SUS 316 / AISI 316 stainless steel for food and chemical industries
- Supports VESA mount
- Rotary switch adjust different touch mode for Hand/Rain/Glove application
- Emergency and Flat buttons for automation device control

W10L100-SPH1-B, 10.1-inch Stainless B Series Display

Stainless IP65 with Waterproof Connector Solutions

Display Specification

Resolution	1024 x 600
Contrast Ratio	800:1
Brightness	450
Viewing Angle	75,80,80,80
Max Colors	16.7M
Touch	Projected capacitive multi touch screen

Interface

USB	1 x M12 waterproof connector for touch screen control
VGA	1x M12 type connector for VGA input
HDMI	1x M21 type connector for HDMI input (Optional)
Power Input	1 x M12 waterproof connector for 12V DC
Expansion Port	CN1 and CN2 for front button control
COM Port	1 x M12 waterproof RS232 connector for touch mode select

Keyboard and Input

Physical Buttons	Rear side: 1 x Power Button 1 x Adjust up button 1 x Adjust down button 1 x ESC (Auto) button 1 x OK (Menu) button Front side: 1 x Emergency Button & 3 x Flat Button for CN1 & CN2 M12 connector
LED Indicators	1 x LED Indicator for power 1 x LED Indicator for status

Power Management

Power Input	Default 12V DC input 9~36V DC input for optional
AC Adapter	100~240V AC to DC Adapter with waterproof connector

Mechanical Specifications

Dimensions	293 x 250 x 69 mm
Housing	SUS 316/ AISI 316 stainless steel
Mounting	VESA Mount / Yoke mount(optional)

Environment

Operating Temperature	0~45°C
Storage Temperature	-20~60°C
Operating Humidity	10% to 90% (Non-condensing)
IP Rating	IP65

Accessories

Standard Accessories

100~240V AC to DC Adapter with waterproof connector
Power Cord
External USB cable with waterproof connector for touchscreen control
External VGA cable with waterproof connector
Waterproof caps
Manual
VESA screws

Optional Accessories

External HDMI cable with waterproof connector
External RS232 Cable with Waterproof Connector

Standards and Certification

EMC CE, FCC

Drawing

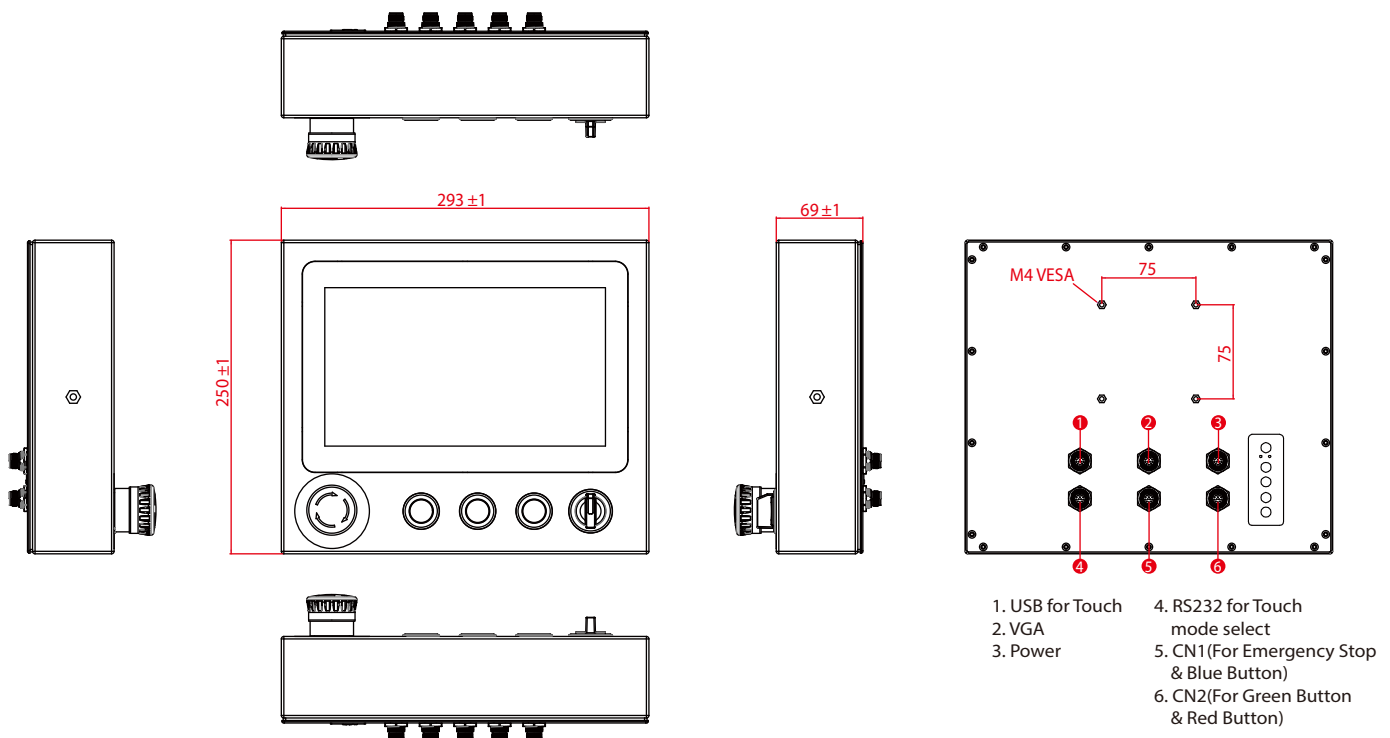

W10L100-SPH1-B, 10.1-inch Stainless B Series Display

Stainless IP65 with Waterproof Connector Solutions

Accessories

Power Cable

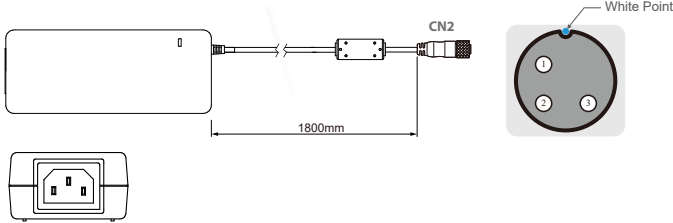

Pin No.	Symbols	Color		Pin No.	Symbols	Color
CN1-1	VIN -	NO ASSIGN	↔	CN2-1	VCC+	Flow Adapter
CN1-2	VIN -	NO ASSIGN	↔	CN2-2	GND	Flow Adapter
CN1-3	VIN -	NO ASSIGN	↔	CN2-3	VCC -	Flow Adapter

USB Cable

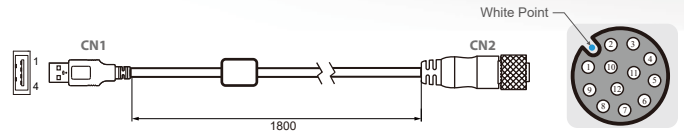

Pin No.	Symbols	Color		Pin No.	Symbols	Color
CN1-2	VCC	Red	↔	CN2-1	VCC	Red
CN1-3	D-	White	↔	CN2-2	D-	White
CN1-4	D+	Green	↔	CN2-3	D+	Green
CN1-5	GND	Black	↔	CN2-4	GND	Black
CN1-9	GND	Black	↔	CN2 Shield	Black	

Twisted pairs

VGA Cable

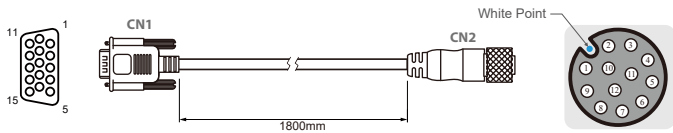

Pin No.	Symbols	Color		Pin No.	Symbols	Color
CN1-1	R	Red	↔	CN2-1	R	Red
CN1-6	R-GND	Black	↔	CN2-2	R-GND	Black
CN1-2	G	Green	↔	CN2-3	G	Green
CN1-7	G-GND	Black	↔	CN2-4	G-GND	Black
CN1-3	B	Blue	↔	CN2-5	B	Blue
CN1-8	B-GND	Black	↔	CN2-6	B-GND	Black
CN1-12	SDA	Yellow	↔	CN2-7	SDA	Yellow
CN1-13	HS	Orange	↔	CN2-8	HS	Orange
CN1-14	VS	White	↔	CN2-9	VS	White
CN1-15	SCL	Brown	↔	CN2-10	SCL	Brown

coaxial
coaxial
coaxial

Push-button extension Cable for Connector 1

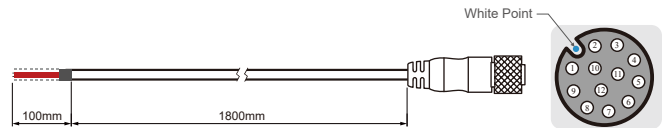

Pin No.	Symbols	Color
CN1-1	Emergency NC 2	Emergency Stop
CN1-2	Emergency NC 1	
CN1-3	Emergency NC 2	
CN1-4	Emergency NC 1	Blue Button
CN1-5	Blue NO 4	
CN1-6	Blue NO 3	
CN1-7	Blue NC 2	
CN1-8	Blue NC 1	
CN1-9		
CN1-10	N/A	
CN1-11		
CN1-12		

Push-button extension Cable for Connector 2

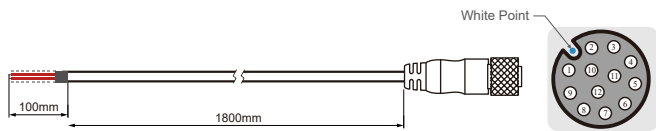

Pin No.	Symbols	Color
CN2-1	Red NO 4	Green Button
CN2-2	Red NO 3	
CN2-3	Red NC 2	
CN2-4	Red NC 1	Red Button
CN2-5	Green NO 4	
CN2-6	Green NO 3	
CN2-7	Green NC 2	
CN2-8	Green NC 1	
CN2-9	N/A	
CN2-10	N/A	
CN2-11	N/A	
CN2-12	N/A	

RS232 Cable

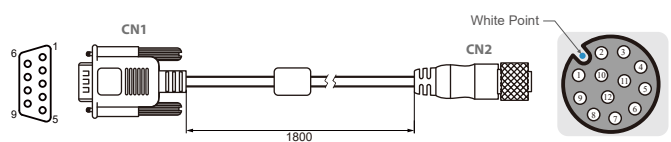

Pin No.	Symbols	Color		Pin No.	Symbols	Color
CN1-1	DCD-CON2	Green	↔	CN2-1	DCD-CON2	Green
CN1-6	DSR-CON2	Brown	↔	CN2-2	DSR-CON2	Brown
CN1-2	RXD-CON2	Red	↔	CN2-3	RXD-CON2	Red
CN1-7	RTS-CON2	Orange	↔	CN2-4	RTS-CON2	Orange
CN1-3	TXD-CON2	Blue	↔	CN2-5	TXD-CON2	Blue
CN1-8	CTS-CON2	White	↔	CN2-6	CTS-CON2	White
CN1-4	DTR-CON2	Purple	↔	CN2-7	DTR-CON2	Purple
CN1-9	RI-CON2	Yellow	↔	CN2-8	RI-CON2	Yellow
CN1-5	GND-CON2	Black	↔	CN2-9	GND-CON2	Black