

EAC Mini EACIL21 – IoT Gateway with USB Type-C

Connect Everything, Control Everywhere

EAC Mini EACIL21 is an industrial IoT gateway with low power consuming Intel® Apollo Lake N3350 processor and USB Type-C video output. Wireless connectivity and all necessary connectors allow the EAC Mini EACIL21 to send data from manufacturing facilities directly to cloud server. Compact size and One-Cable design (USB Type-C Alt mode) make EAC Mini suitable for IoT, smart factory and machine automation applications. The EACIL21 is Microsoft Azure Certified for IoT and AWS IoT Green-grass Certified.



Highlights

- Intel® Apollo Lake N3350 1.1 GHz
- Fanless cooling system
- Compact size 100 x 115 x 31 mm (w/o mounting bracket)
- USB Type-C Port (Alt Mode, output Max 15W)
- Various mounting options: desk, wall, VESA
- Suitable for smart factory applications

Order information

EACIL21-100-A464	Intel N3350, 4G RAM, 64GB eMMC, 1 x USB Type-C, 2 x USB Type-A, 2 x LAN,
EACIL21-101-A464	Intel N3350, 4G RAM, 64GB eMMC, 1 x USB Type-C, 2 x USB Type-A, 2 x LAN, Wi-Fi+BT



EAC Mini EACIL21 – IoT Gateway with USB Type-C

Connect Everything, Control Everywhere

System Specifications

CPU	Intel® Apollo Lake N3350, 1.1 GHz
Graphics Processor	Intel® HD Graphics
BIOS	Insyde UEFI
Watchdog Timer	Programmable 256 levels, timer interval 1 to 255 sec.
System Memory	4GB LPDDR3 1866 MHz

Storage

eMMC	Onboard 64GB (default), up to 128GB
------	-------------------------------------

Interface

USB	2 x USB Type-A 2.0 1 x USB Type-C [Alt Mode] : - Display Port A/V output - USB data (Alt Mode) - Power Delivery up to 15W(5V/ 3A)
Ethernet LAN	2 x Giga LAN RJ45 Connector
Power Input	Terminal Block / 2 Pin

Buttons and LED Indicators

LED Indicator	1 x Power
Button	1 x Power Button 1 x Reset Button

Power Management

Power Input	9~36 V DC
Grounding Protection	Chassis Grounding

Mechanical Specifications

Dimensions	100 x 115 x 31mm
Weight	0.8 kg
Mounting	Desk Mounting (Default), Wall Mounting (Default), VESA Mounting (Optional)
Cooling System	Fanless
Enclosure	Metal Housing

Environment

Operating Temperature	0~55°C
Storage Temperature	-15~70°C
Operating Humidity	10~90% RH (non-condensing)
Shock	Operating, IEC60068-2-27
Vibration	Operating, IEC60068-2-64
IP Rating	IP30

Standards and Certification

EMC	CE, FCC
IoT	Microsoft Azure Certified for IoT AWS IoT Greengrass Certified

Operating System (Optional)

OS	Windows® 10 IoT Enterprise Ubuntu 16.04
----	--------------------------------------------

Accessories

Standard Accessories

Quick Start Guide	91521110103I
Driver CD	91711110100V
Terminal Block 2 pin to 2.5Ø Female Adapter Cable	94J602G020K2
Open Wire Cable with terminal block 2 pin connector	94EL02X020E0
WLAN External Antenna (For EACIL21-101-A464)	397SM000000D

Optional Accessories

VESA Mount Kit	98K000A000BJ
AC Adapter 12V/36W	92D036W12V6
USB Type-C male Cable	9480240240K7
Single-side Lockable USB Type-C Cable	9480240240K5
Dual-side Lockable USB Type-C Cable	9480240240K6

Drawing

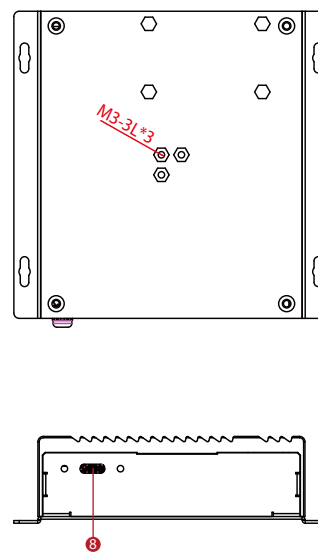
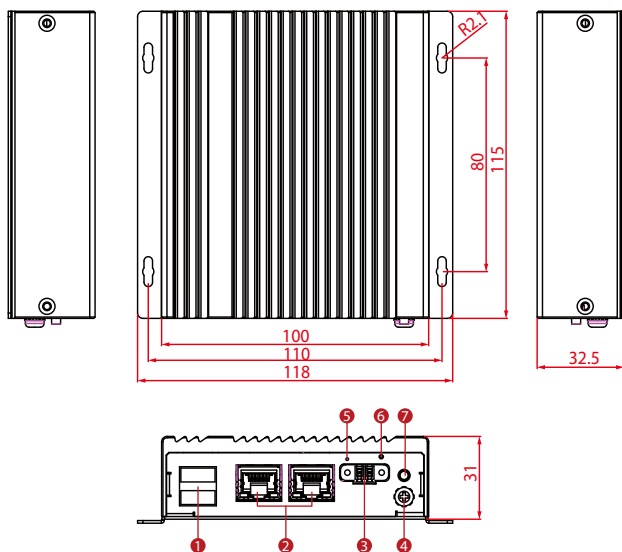

1. 2 x USB Type-A 2.0
2. 2 x LAN port
3. Terminal Block for power
4. Chassis Grounding
5. Power LED Indicator
6. Reset Button
7. Power Button
8. USB Type-C (Alt Mode)
9. Optional SMA Antenna for Wi-Fi

Optional Connector Configuration:

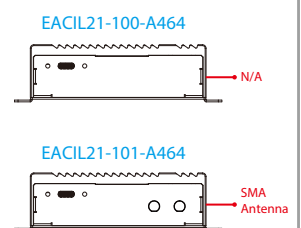

EAC Mini EACIL21 – IoT Gateway with USB Type-C

Connect Everything, Control Everywhere

Pin Assignment of Cables

USB Type-C

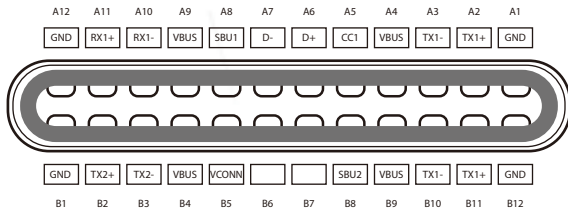

Pin No.	Symbols	Color
A1	GND	
A2	TX1+	Blue
A3	TX1-	White
A4	VBUS	Red
A5	CC1	Blue
A6	D+	Green
A7	D-	White
A8	SBUS1	Red
A9	VBUS	Red
A10	RX2-	White
A11	RX2+	Orange
A12	GND	

Pin No.	Symbols	Color
B1	GND	
B2	TX2+	Purple
B3	TX2-	White
B4	VBUS	Red
B5	VCONN	Yellow
B6	NC	
B7	NC	
B8	SBUS2	Black
B9	VBUS	Red
B10	RX1-	White
B11	RX1+	Yellow
B12	GND	

Terminal Block to DC Jack Cable

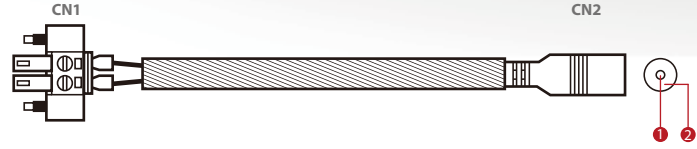

Pin No.	Symbols	Color
CN1-1	VCC	White
CN1-2	GND	Black

Pin No.	Symbols	Color
CN2-1	VCC	White
CN2-2	GND	Black

Open Wire DC Cable

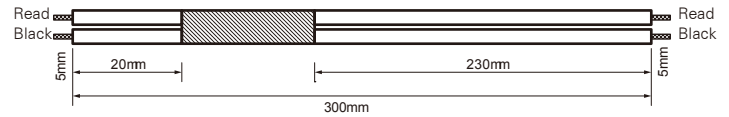

Wire Color	Description
Black	GND
Red	VCC

USB Type-C male to male Cable

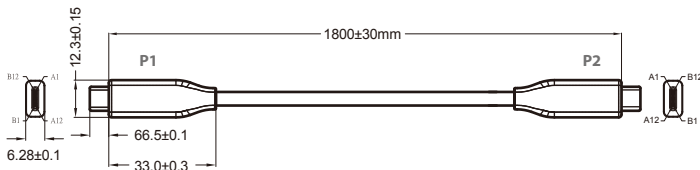

Single-side Lockable USB Type-C Cable

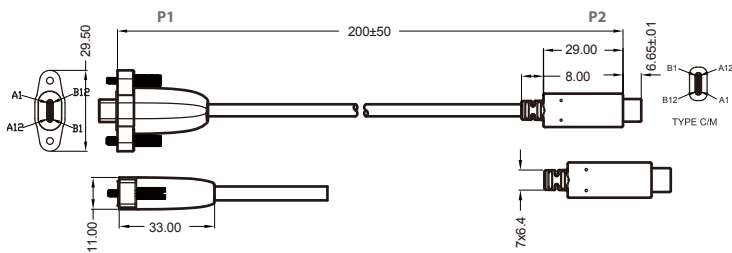

Dual-side Lockable USB Type-C Cable

